

Media-separated solenoid valves are an important component in the control of fluids in systems. With these direct or pilot operated valves only the fluid housing and the separating diaphragm come into contact with the medium. Thus, these valves can withstand many different media (see resistance chart).

In addition, the brass housing meets all the conventional potable water requirements. The pilot operated valve is normally closed in the basic position. By simply turning the 3/2-way pilot valve, the basic position can be changed to normally open.

Housing	Brass
Valve seat	Brass and stainless steel
Internal parts	Brass and stainless steel
Medium	Neutral media, e.g. compressed air, water, hydraulic oil (NBR + FPM) Hot air, per solutions, hot oils (FPM)
Medium temperature	0 °C to 80 °C (NBR) 0 °C to 90 °C (FPM)
Installation position	Any, preferably actuator face up
Operating pressure	0.2 - 10 bar
Electrical connection	Pin terminal acc. to DIN EN 175301-803
Voltage tolerance	±10 %
Nominal operating mode	Continuous operation 100 % duty cycle
Protection IP	IP 65 (with connector socket fitted acc. to DIN EN 175301 - 803)
Switching times	Opening: 0.1...0.8 Sek. Closing: 1.0...4.0 Sek.
Insulation class	H

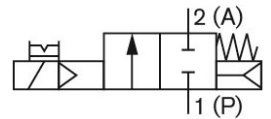

**Materials**

No.	Element	Material
1	Coil	Epoxy
2	O-rings	NBR / FPM
3	Cover	Brass DN 13 stainless steel 1.4408 DN 20 to DN 50 stainless steel 1.4581
4	Springs	Stainless steel 1.4310
5	Diaphragm	NBR / FPM
6	Diaphragm holder	Brass, stainless steel 1.4401
7	Valve body	Brass DN 13 stainless steel CF3M DN 20 bis DN 50 stainless steel 1.4581
8	Manual override	PA

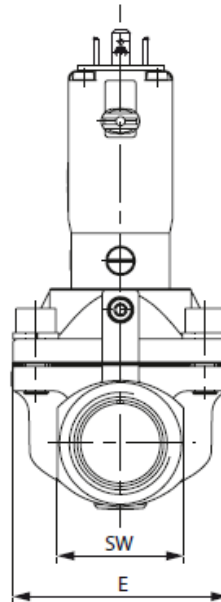
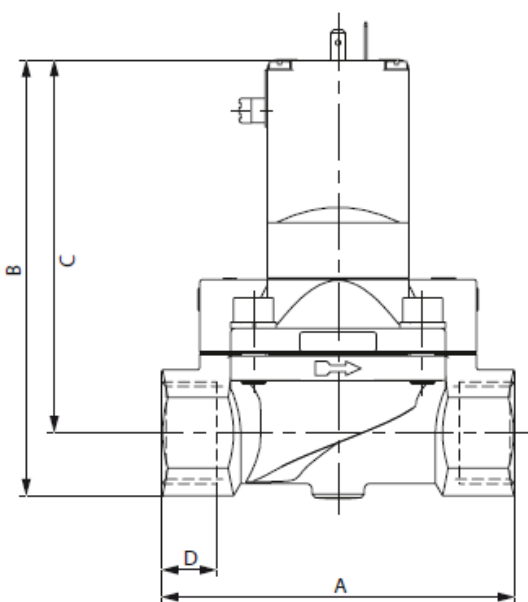
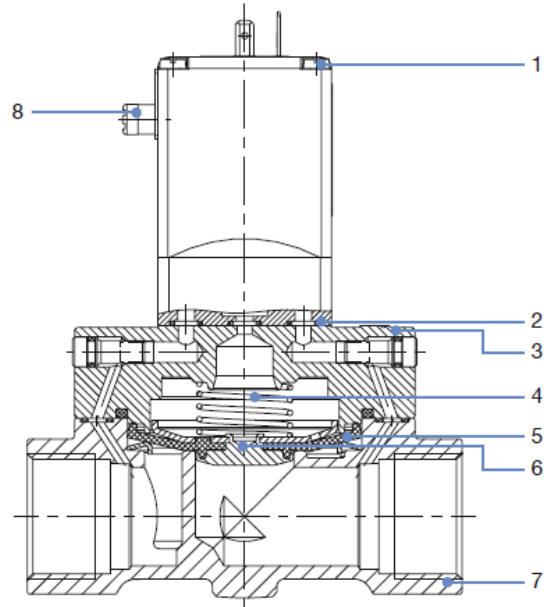

### Media-separated 2/2-way solenoid valve, normally closed pilot-operated, alternating current

Art. No.	Type No.	Thread	DN	Voltage	Sealant	A mm	B mm	C mm	D mm	E mm	SW mm
124891	MVA.12.MS.230.N.BV.13	G 1/2	13	230V AC	NBR	65.0	123.0	109.0	14.0	40.0	27
124853	MVA.12.MS.230.F.BV.13	G 1/2	13	230V AC	FPM	65.0	123.0	109.0	14.0	40.0	27
124889	MVA.12.MS.110.N.BV.13	G 1/2	13	110V AC	NBR	65.0	123.0	109.0	14.0	40.0	27
124852	MVA.12.MS.110.F.BV.13	G 1/2	13	110V AC	FPM	65.0	123.0	109.0	14.0	40.0	27
124887	MVA.12.MS.24A.N.BV.13	G 1/2	13	24V AC	NBR	65.0	123.0	109.0	14.0	40.0	27
124886	MVA.12.MS.24A.F.BV.13	G 1/2	13	24V AC	FPM	65.0	123.0	109.0	14.0	40.0	27
125780	MVA.34.MS.230.N.BV.20	G 3/4	20	230V AC	NBR	100.0	131.0	115.0	16.0	60.0	32
125779	MVA.34.MS.230.F.BV.20	G 3/4	20	230V AC	FPM	100.0	131.0	115.0	16.0	60.0	32
125778	MVA.34.MS.110.N.BV.20	G 3/4	20	110V AC	NBR	100.0	131.0	115.0	16.0	60.0	32
125777	MVA.34.MS.110.F.BV.20	G 3/4	20	110V AC	FPM	100.0	131.0	115.0	16.0	60.0	32
125782	MVA.34.MS.24A.N.BV.20	G 3/4	20	24V AC	NBR	100.0	131.0	115.0	16.0	60.0	32
125781	MVA.34.MS.24A.F.BV.20	G 3/4	20	24V AC	FPM	100.0	131.0	115.0	16.0	60.0	32
124741	MVA.1.MS.230.N.BV.25	G 1	25	230V AC	NBR	115.0	142.0	121.5	18.0	70.0	41
124740	MVA.1.MS.230.F.BV.25	G 1	25	230V AC	FPM	115.0	142.0	121.5	18.0	70.0	41
124739	MVA.1.MS.110.N.BV.25	G 1	25	110V AC	NBR	115.0	142.0	121.5	18.0	70.0	41
124705	MVA.1.MS.110.F.BV.25	G 1	25	110V AC	FPM	115.0	142.0	121.5	18.0	70.0	41
124743	MVA.1.MS.24A.N.BV.25	G 1	25	24V AC	NBR	115.0	142.0	121.5	18.0	70.0	41
124742	MVA.1.MS.24A.F.BV.25	G 1	25	24V AC	FPM	115.0	142.0	121.5	18.0	70.0	41
124760	MVA.114.MS.230.N.BV.32	G 1 1/4	32	230V AC	NBR	126.0	147.0	122.0	20.0	85.0	50
124759	MVA.114.MS.230.F.BV.32	G 1 1/4	32	230V AC	FPM	126.0	147.0	122.0	20.0	85.0	50
124758	MVA.114.MS.110.N.BV.32	G 1 1/4	32	110V AC	NBR	126.0	147.0	122.0	20.0	85.0	50
124757	MVA.114.MS.110.F.BV.32	G 1 1/4	32	110V AC	FPM	126.0	147.0	122.0	20.0	85.0	50
124843	MVA.114.MS.24A.N.BV.32	G 1 1/4	32	24V AC	NBR	126.0	147.0	122.0	20.0	85.0	50
124842	MVA.114.MS.24A.F.BV.32	G 1 1/4	32	24V AC	FPM	126.0	147.0	122.0	20.0	85.0	50
124852	MVA.112.MS.230.N.BV.40	G 1 1/2	40	230V AC	NBR	126.0	156.0	126.0	22.0	85.0	60
124751	MVA.112.MS.230.F.BV.40	G 1 1/2	40	230V AC	FPM	126.0	156.0	126.0	22.0	85.0	60
124750	MVA.112.MS.110.N.BV.40	G 1 1/2	40	110V AC	NBR	126.0	156.0	126.0	22.0	85.0	60
124749	MVA.112.MS.110.F.BV.40	G 1 1/2	40	110V AC	FPM	126.0	156.0	126.0	22.0	85.0	60
124857	MVA.112.MS.24A.N.BV.40	G 1 1/2	40	24V AC	NBR	126.0	156.0	126.0	22.0	85.0	60
124753	MVA.112.MS.24A.F.BV.40	G 1 1/2	40	24V AC	FPM	126.0	156.0	126.0	22.0	85.0	60
125765	MVA.2.MS.230.N.BV.50	G 2	50	230V AC	NBR	164.0	177.5	142.5	24.0	115.0	70
125764	MVA.2.MS.230.F.BV.50	G 2	50	230V AC	FPM	164.0	177.5	142.5	24.0	115.0	70
125763	MVA.2.MS.110.N.BV.50	G 2	50	110V AC	NBR	164.0	177.5	142.5	24.0	115.0	70
125762	MVA.2.MS.110.F.BV.50	G 2	50	110V AC	FPM	164.0	177.5	142.5	24.0	115.0	70
125767	MVA.2.MS.24A.N.BV.50	G 2	50	24V AC	NBR	164.0	177.5	142.5	24.0	115.0	70
125766	MVA.2.MS.24A.F.BV.50	G 2	50	24V AC	FPM	164.0	177.5	142.5	24.0	115.0	70
125774	MVA.212.MS.230.N.BV.65	G 2 1/2	65	230V AC	NBR	180.0	185.0	142.5	27.0	115.0	85
125772	MVA.212.MS.230.F.BV.65	G 2 1/2	65	230V AC	FPM	180.0	185.0	142.5	27.0	115.0	85
125773	MVA.212.MS.110.N.BV.65	G 2 1/2	65	110V AC	NBR	180.0	185.0	142.5	27.0	115.0	85
125770	MVA.212.MS.110.F.BV.65	G 2 1/2	65	110V AC	FPM	180.0	185.0	142.5	27.0	115.0	85
125776	MVA.212.MS.24A.N.BV.65	G 2 1/2	65	24V AC	NBR	180.0	185.0	142.5	27.0	115.0	85

➔ Solenoid valves are supplied without a connector socket as standard. The connector socket must be ordered separately if required.

### Media-separated 2/2-way solenoid valve, normally closed pilot-operated, direct current

Art. No.	Type No.	Thread	DN	Voltage	Sealant	A mm	B mm	C mm	D mm	E mm	SW mm
124888	MVA.12.MS.24D.N.BV.13	G 1/2	13	24V DC	NBR	65.0	123.0	109.0	14.0	40.0	27
124892	MVA.12.MS.24D.F.BV.13	G 1/2	13	24V DC	FPM	65.0	123.0	109.0	14.0	40.0	27
125784	MVA.34.MS.24D.N.BV.20	G 3/4	20	24V DC	NBR	131.0	115.0	16.0	60.0	131.0	32
125783	MVA.34.MS.24D.F.BV.20	G 3/4	20	24V DC	FPM	131.0	115.0	16.0	60.0	131.0	32
124748	MVA.1.MS.24D.N.BV.25	G 1	25	24V DC	NBR	115.0	142.0	121.5	18.0	70.0	41
124747	MVA.1.MS.24D.F.BV.25	G 1	25	24V DC	FPM	115.0	142.0	121.5	18.0	70.0	41
124851	MVA.114.MS.24D.N.BV.32	G 1 1/4	32	24V DC	NBR	126.0	147.0	122.0	20.0	85.0	50
124850	MVA.114.MS.24D.F.BV.32	G 1 1/4	32	24V DC	FPM	126.0	147.0	122.0	20.0	85.0	50
124756	MVA.112.MS.24D.N.BV.40	G 1 1/2	40	24V DC	NBR	126.0	156.0	126.0	22.0	85.0	60
124755	MVA.112.MS.24D.F.BV.40	G 1 1/2	40	24V DC	FPM	126.0	156.0	126.0	22.0	85.0	60
125769	MVA.2.MS.24D.N.BV.50	G 2	50	24V DC	NBR	164.0	177.5	142.5	24.0	115.0	70
125768	MVA.2.MS.24D.F.BV.50	G 2	50	24V DC	FPM	164.0	177.5	142.5	24.0	115.0	70
125771	MVA.212.MS.24D.N.BV.65	G 2 1/2	65	24V DC	NBR	180.0	185.0	142.5	27.0	115.0	85
125775	MVA.212.MS.24D.F.BV.65	G 2 1/2	65	24V DC	FPM	180.0	185.0	142.5	27.0	115.0	85

→ Solenoid valves are supplied without a connector socket as standard. The connector socket must be ordered separately if required.

### Characteristics valve body /electrical data

Connec tion	DN	Flow coefficient (Kv) water* m <sup>3</sup> /h)	Pickup ~ VA	Power Holding ~ VA / W	hot / cold = W	Ambient temperature °C	Surface temperature coil housing °C **	Coil Insulation class H °C **
G 1/2	13	4.0	24	14 / 8	11 / 8	0 to 55	max. 100	max. 180
G 3/4	20	6.5						
G 1	25	10.0						
G 1 1/4	32	20.0						
G 1 1/2	40	20.0						
G 2	50	40.0						
G 2 1/2	65	40.0						

\* Measurement at + 20 °C, 1 bar pressure at the valve inlet and free outlet, a pressure difference of 0.5 bar is required to open the full cross-section.

\*\* It must be ensured that the temperature of the coil can be dissipated to the ambient air.

All temperature specifications are designed for 100% duty cycle.

## Mounting options

Solenoid valves are delivered in NC position. Turning the pilot valve through 180° changes the circuit function of the valve.

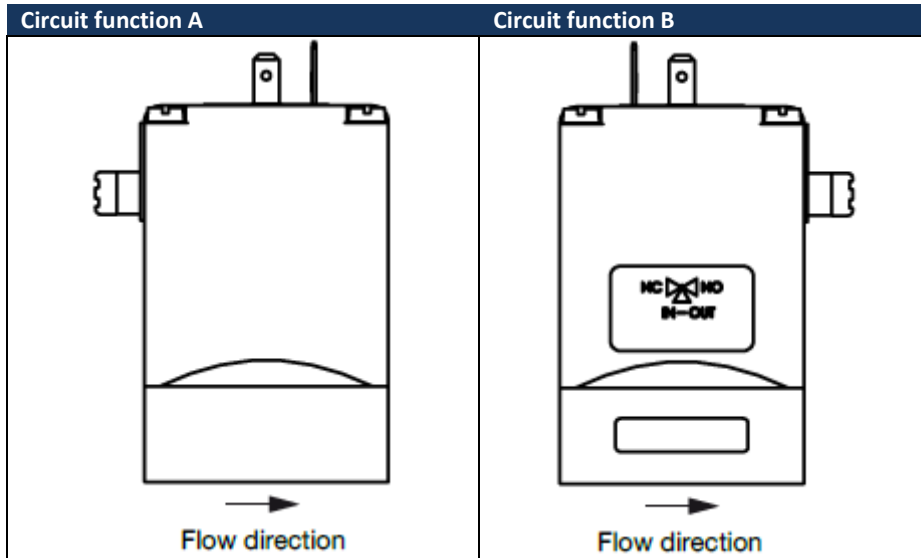

## 3/2-way pilot valve

Art. No.	Type No.	Sealant	Voltage
129201	MPV.W.MS.24A.N	NBR	24V AC
129203	MPV.W.MS.24A.F	FPM	24V AC
129197	MPV.W.MS.24D.N	NBR	24V DC
129202	MPV.W.MS.24D.F	FPM	24V DC
129198	MPV.W.MS.110.N	NBR	110V
129204	MPV.W.MS.110.F	FPM	110V
129200	MPV.W.MS.230.N	NBR	230V
129199	MPV.W.MS.230.F	FPM	230V



**Connector socket**

Cover	Polyamide
Contact	Brass
Sealant	NBR
Cable outlet	Can be rotated through 4x90°
Cable gland	M16x1.5
Continuous maximum temperature	-40 °C to 125 °C (connector socket) -30 °C to 90 °C (NBR sealant)
Electrical connection	Acc. to DIN EN 175301-803

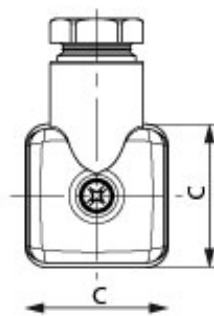
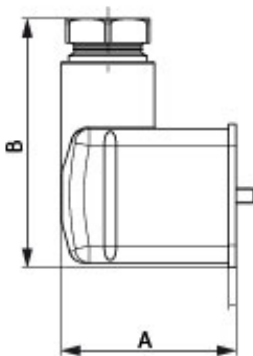

**Connector socket for media-separated solenoid valve**

Art. No.	Type No.	Protection IP	Voltage	Version	A mm	B mm	C mm
124691	GS.MV.0-250V	IP65/IP67	0-250 V AC/DC	without circuitry	35.7	51.0	29.2
124702	GS.MV.12-24V	IP65	12-24 V AC/DC	with LED	35.7	51.0	29.2
129205	GS.MV.LED.240V	IP65	200-240 V AC/DC	with LED	35.7	51.0	29.2

## Set of wearing parts

Set of wearing parts				
Art. No.	Type No.	DN	Sealant	Description
129206	VTSMV.13N	13	NBR	Spring, NBR diaphragm, O-Ring housing, O-Ring relief piston
129208	VTSMV.13.F	13	FPM	Spring, FPM diaphragm, O-Ring housing, O-Ring relief piston
129210	VTSMV.20.N	20	NBR	Spring, NBR diaphragm, O-Ring housing, O-Ring relief piston
129211	VTSMV.20.F	20	FPM	Spring, FPM diaphragm, O-Ring housing, O-Ring relief piston
129207	VTSMV.25.N	25	NBR	Spring, NBR diaphragm, O-Ring housing, O-Ring relief piston
129215	VTSMV.25.F	25	FPM	Spring, FPM diaphragm, O-Ring housing, O-Ring relief piston
129209	VTSMV.3240.N	32, 40	NBR	Spring, NBR diaphragm, O-Ring housing, O-Ring relief piston
129212	VTSMV.3240.F	32, 40	FPM	Spring, FPM diaphragm, O-Ring housing, O-Ring relief piston
129214	VTSMV.5065.N	50, 65	NBR	Spring, NBR diaphragm, O-Ring housing, O-Ring relief piston
129213	VTSMV.5065.F	50, 65	FPM	Spring, FPM diaphragm, O-Ring housing, O-Ring relief piston

